



DECLARATION OF PERFORMANCE



No. 0007 – EN

1. Unique identification code of the product-type: Injection System fischer FIS V

2. Intended use/es:

Product	Intended use/es
Metal anchors for use in concrete (heavy-duty type)	For fixing and/or supporting concrete structural elements or heavy units such as cladding and suspended ceilings, see appendix, especially Annexes B 1 to B 8

3. Manufacturer: fischerwerke GmbH & Co. KG, Otto-Hahn-Straße 15, 79211 Denzlingen, Germany

4. Authorised representative: --

5. System/s of AVCP: 1

6a. Harmonised standard: ---

Notified body/ies: ---

6b. European Assessment Document: ETAG 001; 2013-04

European Technical Assessment: ETA-02/0024; 2015-01-07

Technical Assessment Body: DIBt

Notified body/ies: 1343 – MPA Darmstadt

7. Declared performance/s:

Mechanical resistance and stability (BWR 1)

Essential characteristic	Performance
Characteristic resistance for design according to TR 029	See appendix, especially Annexes C 1 to C 6
Characteristic resistance for design according to CEN/TS 1992-4:2009	See appendix, especially Annexes C 7 to C 12
Displacements under tension and shear loads	See appendix, especially Annexes C 13, C 14

Safety in case of fire (BWR 2)

Essential characteristic	Performance
Reaction to fire	Anchorage satisfy requirements for Class A1
Resistance to fire	No performance determined (NPD)

8. Appropriate Technical Documentation and/or Specific Technical Documentation: ---

The performance of the product identified above is in conformity with the set of declared performance/s. This declaration of performance is issued, in accordance with Regulation (EU) No 305/2011, under the sole responsibility of the manufacturer identified above.

Signed for and on behalf of the manufacturer by:

Andreas Bucher, Dipl.-Ing.

Wolfgang Hengesbach, Dipl.-Ing., Dipl.-Wirtsch.-Ing.

i.V. A. Bucher

i.V. W. Hengesbach

Tumlingen, 2015-02-05

- This DoP has been prepared in different languages. In case there is a dispute on the interpretation the english version shall always prevail.

- The Appendix includes voluntary and complementary information in English language exceeding the (language-neutrally specified) legal requirements.

Specific Part

1 Technical description of the product

The fischer injection system FIS V is a bonded anchor consisting of a cartridge with injection mortar fischer FIS V and a steel element. The steel element consist of

- a fischer threaded rod FIS A or RGM of sizes M6 to M30 or
- a internal threaded anchor RG MI of sizes M8 to M20 or
- a deformed reinforcing bar of sizes $\phi = 8$ to 28 mm or
- a fischer rebar anchor FRA of sizes M12 to M24

The steel element is placed into a drilled hole filled with injection mortar and is anchored via the bond between metal part, injection mortar and concrete.

The product description is given in Annex A.

2 Specification of the intended use in accordance with the applicable European Assessment Document

The performances given in Section 3 are only valid if the anchor is used in compliance with the specifications and conditions given in Annex B.

The verifications and assessment methods on which this European Technical Assessment is based lead to the assumption of a working life of the anchor of at least 50 years. The indications given on the working life cannot be interpreted as a guarantee given by the producer, but are to be regarded only as a means for choosing the right products in relation to the expected economically reasonable working life of the works.

3 Performance of the product and references to the methods used for its assessment

3.1 Mechanical resistance and stability (BWR 1)

Essential characteristic	Performance
Characteristic resistance for design according to TR 029	See Annex C 1 to C 6
Characteristic resistance for design according to CEN/TS 1992-4:2009	See Annex C 7 to C 12
Displacements under tension and shear loads	See Annex C 13 / C 14

3.2 Safety in case of fire (BWR 2)

Essential characteristic	Performance
Reaction to fire	Anchorage satisfy requirements for Class A1
Resistance to fire	No performance determined (NPD)

3.3 Hygiene, health and the environment (BWR 3)

Regarding dangerous substances there may be requirements (e.g. transposed European legislation and national laws, regulations and administrative provisions) applicable to the products falling within the scope of this European Technical Assessment. In order to meet the provisions of Regulation (EU) No 305/2011, these requirements need also to be complied with, when and where they apply.

3.4 Safety in use (BWR 4)

The essential characteristics regarding Safety in use are included under the Basic Works Requirement Mechanical resistance and stability.

3.5 Protection against noise (BWR 5)

Not applicable.

3.6 Energy economy and heat retention (BWR 6)

Not applicable.

3.7 Sustainable use of natural resources (BWR 7)

The sustainable use of natural resources was not investigated.

3.8 General aspects

The verification of durability is part of testing the essential characteristics. Durability is only ensured if the specifications of intended use according to Annex B are taken into account.

4 Assessment and verification of constancy of performance (AVCP) system applied, with reference to its legal base

According to Decision of the Commission of 24 June 1996 (96/582/EC) (OJ L 254 of 08.10.96 p. 62-65), the system of assessment and verification of constancy of performance (see Annex V and Article 65 Paragraph 2 to Regulation (EU) No 305/2011) given in the following table applies.

Product	Intended use	Level or class	System
Metal anchors for use in concrete (heavy-duty type)	For fixing and/or supporting concrete structural elements or heavy units such as cladding and suspended ceilings	—	1

Installation condition

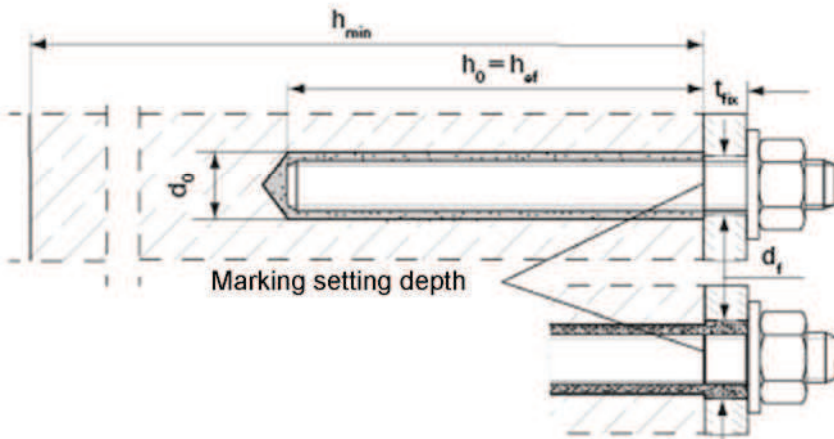

fischer threaded rod
pre-positioned anchorage

fischer threaded rod
push-through anchorage
(annular gap filled with mortar)

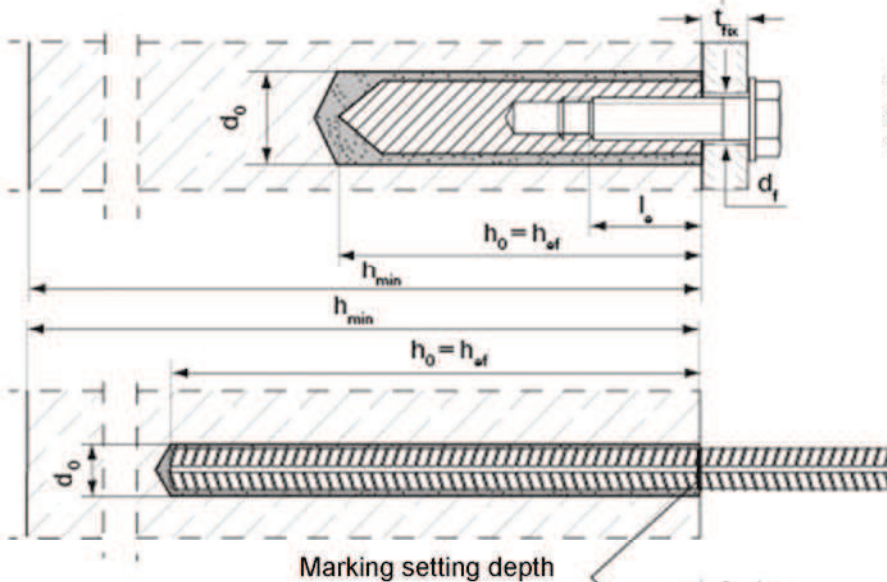

fischer internal threaded anchor RG MI
only pre-positioned anchorage

Reinforcing bar

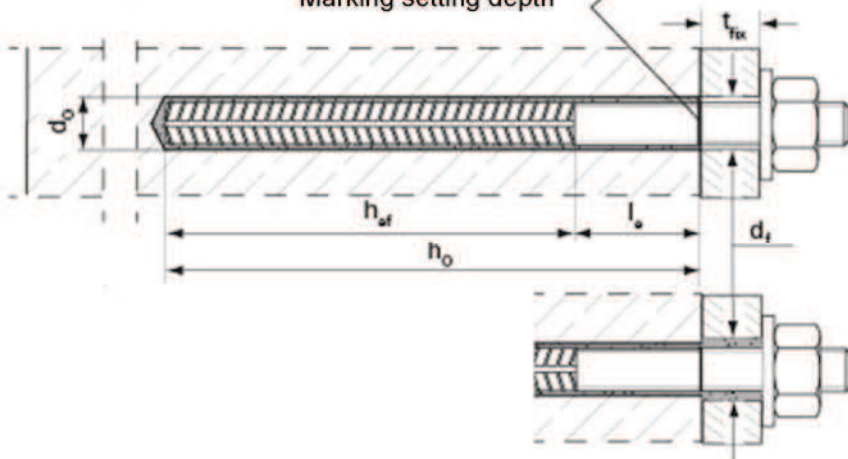

fischer rebar anchor FRA
pre-positioned anchorage

fischer rebar anchor FRA
push-through anchorage
(annular gap filled with mortar)

fischer injection system FIS V

Product description
Installation condition

Annex A 1

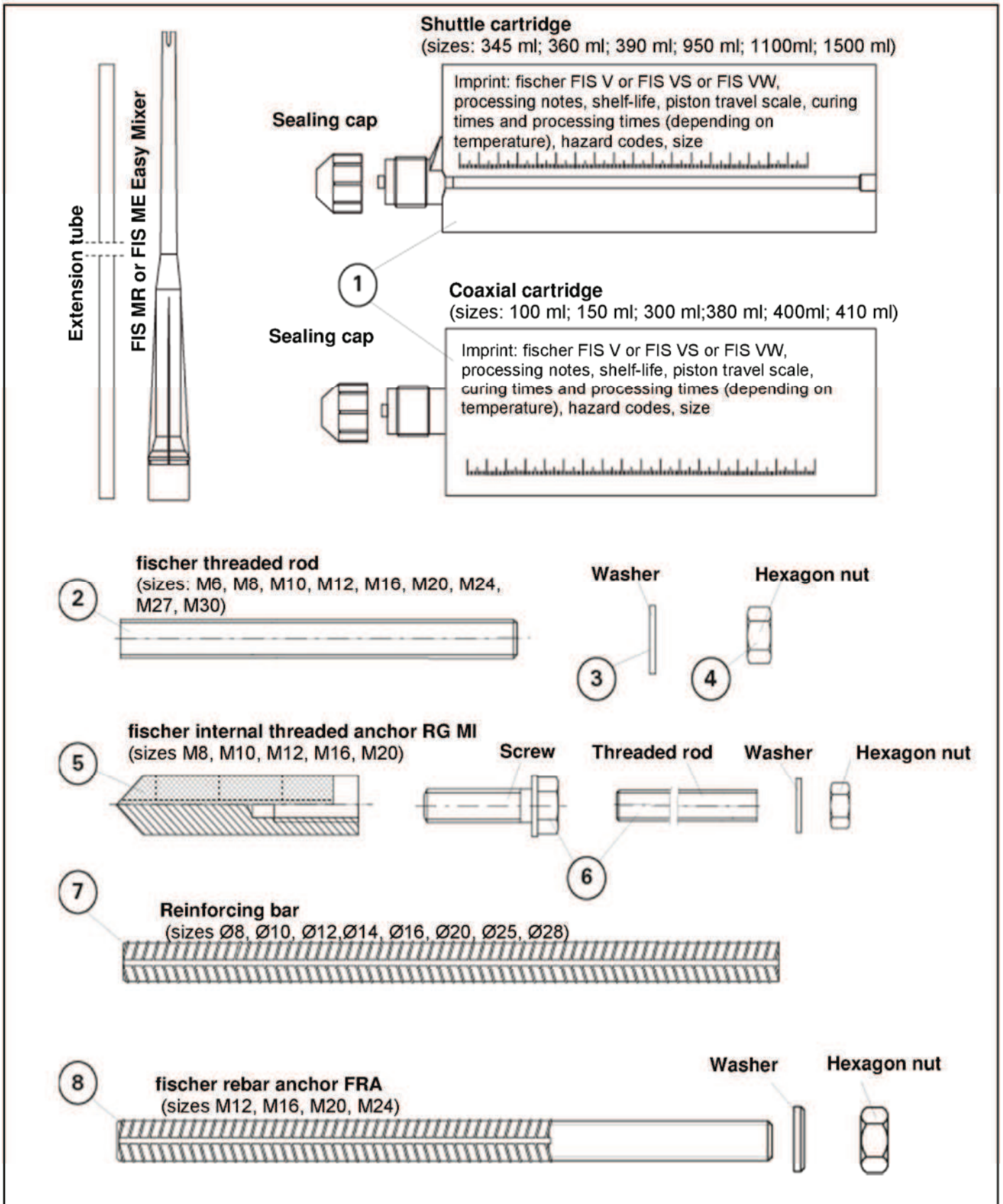

<p>fischer injection system FIS V</p>	<p>Annex A 2</p>
<p>Product description Cartridges / Static mixer / Steel elements</p>	

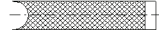

Table A1: Materials

Part	Designation	Material		
1	Mortar cartridge	Mortar, hardener; filler		
		Steel, zinc plated	Stainless steel A4	High corrosion-resistant steel c
2	Threaded rod	Property class 5.8 or 8.8; EN ISO 898-1: 2013 zinc plated $\geq 5\mu\text{m}$, EN ISO 4042:1999 A2K or hot-dip galvanised EN ISO 10684:2004 $f_{uk} \leq 1000 \text{ N/mm}^2$ $A_5 > 8\%$ fracture elongation	Property class 50, 70 or 80 EN ISO 3506:2009 1.4401; 1.4404; 1.4578; 1.4571; 1.4439; 1.4362; 1.4062 EN 10088-1:2014 $f_{uk} \leq 1000 \text{ N/mm}^2$ $A_5 > 8\%$ fracture elongation	Property class 50 or 80 EN ISO 3506:2009 or property class 70 with $f_{yk} = 560 \text{ N/mm}^2$ 1.4565; 1.4529 EN 10088-1:2014 $f_{uk} \leq 1000 \text{ N/mm}^2$ $A_5 > 8\%$ fracture elongation
3	Washer ISO 7089:2000	zinc plated $\geq 5\mu\text{m}$, EN ISO 4042:1999 A2K or hot-dip galvanised EN ISO 10684:2004	1.4401; 1.4404; 1.4578; 1.4571; 1.4439; 1.4362 EN 10088-1:2014	1.4565; 1.4529 EN 10088-1:2014
4	Hexagon nut	Property class 5 or 8; EN ISO 898-2:2013 zinc plated $\geq 5\mu\text{m}$, ISO 4042:1999 A2K or hot-dip galvanised ISO 10684:2004	Property class 50, 70 or 80 EN ISO 3506:2009 1.4401; 1.4404; 1.4578; 1.4571; 1.4571; 1.4439; 1.4362 EN 10088-1:2014	Property class 50, 70 or 80 EN ISO 3506:2009 1.4565; 1.4529 EN 10088-1:2014
5	Internal threaded anchor RG MI	Property class 5.8 or 8.8; EN 10277-1:2008-06 zinc plated $\geq 5\mu\text{m}$, ISO 4042:1999 A2K	Property class 70 EN ISO 3506:2009 1.4401; 1.4404; 1.4578; 1.4571; 1.4439; 1.4362 EN 10088-1:2014	Property class 70 EN ISO 3506-1:2009 1.4565; 1.4529 EN 10088-1:2014
6	Screw or threaded rod for internal threaded anchor	Property class 5.8 or 8.8; EN ISO 898-1:2013 zinc plated $\geq 5\mu\text{m}$, ISO 4042:1999 A2K	Property class 70 EN ISO 3506:2009 1.4401; 1.4404; 1.4578; 1.4571; 1.4439; 1.4362 EN 10088-1:2014	Property class 70 EN ISO 3506-1:2009 1.4565; 1.4529 EN 10088-1:2014
7	Rebar EN 1992-1-1:2004 and AC:2010, Annex C	Bars and de-coiled rods class B or C with f_{yk} and k according to NDP or NCL of EN 1992-1-1/NA:2013 $f_{uk} = f_{tk} = k \cdot f_{yk}$ (k see Annex B4)		
8	Rebar anchor FRA	Rebar part: Bars and de-coiled rods class B or C with f_{yk} and k according to NDP or NCL of EN 1992-1-1/NA:2013 $f_{uk} = f_{tk} = k \cdot f_{yk}$ (k see Annex B4)	Threaded part: Property class 70 ISO 3506:2009 1.4565; 1.4529 EN 10088-1:2014	

fischer injection system FIS V	Annex A 3
Product description Materials	

Specifications of intended use

Table B1: Overview use categories and performance categories

Anchorages subject to		FIS V with ...							
		Threaded rod 		Internal threaded anchor RG MI 		Reinforcing bar 		Rebar anchor FRA 	
Hammer drilling		all sizes							
Static and quasi static load, in	non-cracked concrete	M6 to M30	Tables: C1, C5, C9, C13, C17, C18	M8 to M20	Tables: C2, C6, C10, C14, C19, C20	Ø8 to Ø28	Tables: C3, C7, C11, C15, C21, C22	M12 to M24-	Tables: C4, C8, C12, C16, C23, C24
	cracked concrete	M10 to M30				Ø10 to Ø28			
Use category	Dry or wet concrete	M6 to M30		M8 to M20		Ø8 to Ø28		M12 to M24	
	Flooded hole	M12 to M30		M8 to M20					
Installation temperature		-10°C to +40°C							
In-service temperature	Temperature range I	-40°C to +80°C		(max. long term temperature +50°C and max. short term temperature +80°C)					
	Temperature range II	-40°C to +120°C		(max. long term temperature +72°C and max. short term temperature +120°C)					

Base materials:

- Reinforced or unreinforced normal weight concrete according to EN 206:2013
- Strength classes C20/25 to C50/60 according to EN 206:2013

Use conditions (Environmental conditions):

- Structures subject to dry internal conditions (zinc coated steel, stainless steel or high corrosion resistant steel)
- Structures subject to external atmospheric exposure (including industrial and marine environment) and to permanently damp internal condition, if no particular aggressive conditions exist (stainless steel or high corrosion resistant steel)
- Structures subject to external atmospheric exposure and to permanently damp internal condition, if other particular aggressive conditions (high corrosion resistant steel)
Note: Particular aggressive conditions are e.g. permanent, alternating immersion in seawater or the splash zone of seawater, chloride atmosphere of indoor swimming pools or atmosphere with extreme chemical pollution (e.g. in desulphurization plants or road tunnels where de-icing materials are used).

Design:

- Anchorages have to be designed under the responsibility of an engineer experienced in anchorages and concrete work.
- Verifiable calculation notes and drawings are prepared taking account of the loads to be anchored. The position of the anchor is indicated on the design drawings (e.g. position of the anchor relative to reinforcement or to supports, etc.).
- Anchorages under static or quasi-static actions are designed in accordance with TR 029 "Design of bonded anchors", Edition September 2010 or CEN/TS 1992-4:2009

Installation:

- Anchor installation carried out by appropriately qualified personnel and under the supervision of the person responsible for technical matters of the site.

fischer injection system FIS V	Annex B 1
Intended Use Specifications	

Table B2: Installation parameters threaded rods

Size		M6	M8	M10	M12	M16	M20	M24	M27	M30
Width across flat	SW [mm]	10	13	17 ²⁾	19 ²⁾	24	30	36	41	46
Nominal drill bit diameter	d ₀ [mm]	8	10	12	14	18	24	28	30	35
Drill hole depth	h ₀ [mm]	h ₀ = h _{ef}								
Effective anchorage depth	h _{ef,min} [mm]	50	60	60	70	80	90	96	108	120
	h _{ef,max} [mm]	72	160	200	240	320	400	480	540	600
Maximum torque moment	T _{inst,max} [Nm]	5	10	20	40	60	120	150	200	300
Minimum spacing	s _{min} [mm]	40	40	45	55	65	85	105	125	140
Minimum edge distance	c _{min} [mm]	40	40	45	55	65	85	105	125	140
Diameter of clearance hole in the fixture ¹⁾	Pre-positioned anchorage d _f [mm]	7	9	12	14	18	22	26	30	33
	Push-through anchorage d _f [mm]	9	11	14	16	20	26	30	32	40
Minimum thickness of concrete member	h _{min} [mm]	h _{ef} + 30 (≥ 100)				h _{ef} + 2d ₀				

¹⁾ For larger clearance holes in the fixture see TR 029, 4.2.2.1 or CEN/TS 1992-4-1:2009, 5.2.3.1

²⁾ Deviating to ISO 4032

fischer threaded rods FIS A and RGM

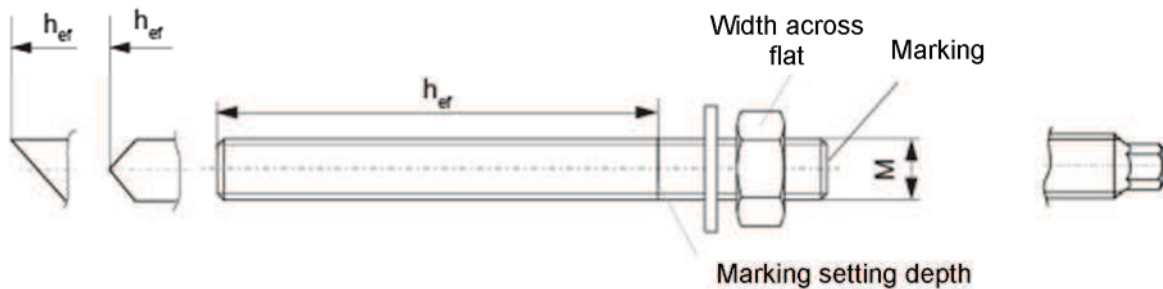

Marking:

- Property class 8.8 or high corrosion-resistant steel C, property class 80: •
- Stainless steel A4, property class 50 or high corrosion-resistant steel C, property class 50:••

Commercial standard threaded rods, washers and hexagon nuts may also be used if the following requirements are fulfilled:

- Materials, dimensions and mechanical properties according Annex A 3, Table A1
- Inspection certificate 3.1 according to EN 10204:2004, the documents should be stored
- Marking of embedment depth

fischer injection system FIS V

Intended Use
Installation parameters threaded rods

Annex B 2

Table B3: Installation parameters internal threaded anchors RG MI

Size		M8	M10	M12	M16	M20
Diameter of anchor	d_H [mm]	12	16	18	22	28
Nominal drill bit diameter	d_0 [mm]	14	18	20	24	32
Drill hole depth	h_0 [mm]	$h_0 = h_{ef}$				
Effective anchorage depth ($h_{ef} = L_H$)	h_{ef} [mm]	90	90	125	160	200
Maximum torque moment	$T_{inst,max}$ [Nm]	10	20	40	80	120
Minimum spacing	s_{min} [mm]	55	65	75	95	125
Minimum edge distance	c_{min} [mm]	55	65	75	95	125
Diameter of clearance hole in the fixture ¹⁾	d_f [mm]	9	12	14	18	22
Minimum thickness of concrete member	h_{min} [mm]	120	125	165	210	265
Maximum screw-in depth	$l_{E,max}$ [mm]	18	23	26	35	45
Minimum screw-in depth	$l_{E,min}$ [mm]	8	10	12	16	20

¹⁾ For larger clearance holes in the fixture see TR 029, 4.2.2.1 or CEN/TS 1992-4-1:2009, 5.2.3.1

fischer internal threaded anchor RG MI

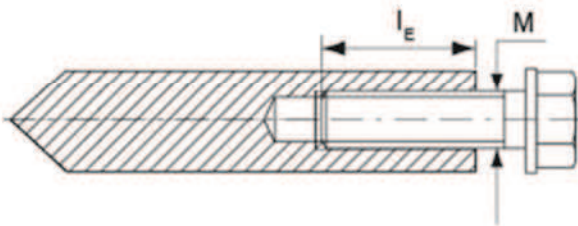

Marking: anchor size e.g.: M10
 Stainless steel in addition A4 e.g.: M10 A4
 High corrosion-resistant steel in addition C e.g.: M10 C

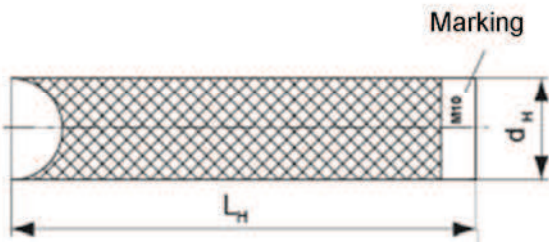

Fastening screw or threaded rods including washer and nuts must comply with the appropriate material and strength class of table A1

fischer injection system FIS V

Intended Use
 Installation parameters internal threaded anchors RG MI

Annex B 3

Table B4: Installation parameters reinforcing bars

Rebar diameter	Ø	8 ¹⁾	10 ¹⁾	12 ¹⁾	14	16	20	25	28	
Nominal drill bit diameter	d ₀	[mm]	(10)12	(12)14	(14) 16	18	20	25	30	35
Drill hole depth	h ₀	[mm]	h ₀ = h _{ef}							
Effective anchorage depth	h _{ef,min}	[mm]	60	60	70	75	80	90	100	112
	h _{ef,max}	[mm]	160	200	240	280	320	400	500	560
Minimum spacing	s _{min}	[mm]	40	45	55	60	65	85	110	130
Minimum edge distance	c _{min}	[mm]	40	45	55	60	65	85	110	130
Minimum thickness of concrete member	h _{min}	[mm]	h _{ef} + 30 ≥ 100			h _{ef} + 2d ₀				

¹⁾ Both drill bit diameters can be used.

Reinforcing bar

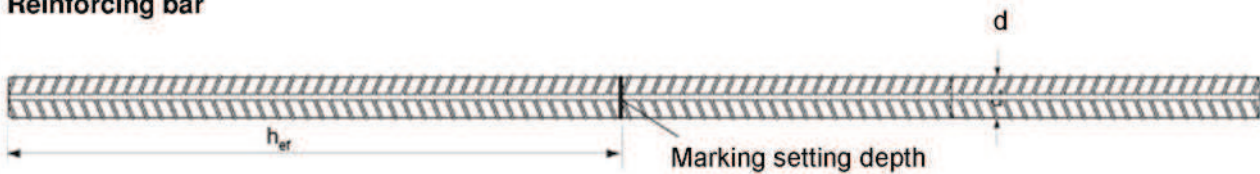

Properties of reinforcement: refer to EN 1992-1-1 Annex C, Table C.1 and C.2N

Product form		Non-zink-plated bars and decoiled rod	
Class		B	C
Characteristic yield strength f _{yk} or f _{0,2k} [MPa]		400 to 600	
Minimum value of k = (f _t /f _{yk})		≥ 1,08	≥ 1,15 < 1,35
Characteristic strain at maximum force ε _{uk} [%]		≥ 5,0	≥ 7,5
Bentability property		Bend / Re bendtest	
Maximum deviation from nominal mass (individual bar) [%]	Nominal bar size [mm]	≤ 8	± 6,0
		> 8	± 4,5
Bond: Minimum relative rib area, f _{R,min} (determination acc. to EN 15630)	Nominal bar size [mm]	8 to 12	0,040
		> 12	0,056

Rib height h:

The rib height h must be:

$$0,05 * d \leq h \leq 0,07 * d$$

d = nominal bar size

fischer injection system FIS V

Intended Use

Installation parameters reinforcing bars

Annex B 4

Table B5: Installation parameters rebar anchor FRA



Threaded diameter		M12 ¹⁾	M16	M20	M24
Diameter of anchor	d [mm]	12	16	20	25
Width across flat	SW [mm]	19	24	30	36
Nominal drill bit diameter	d ₀ [mm]	(14) 16	20	25	30
Drill hole depth	h ₀ [mm]	h _{ef} + ℓ _e			
Distance concrete surface to welded joint	ℓ _e [mm]	100			
Effective anchorage depth	h _{ef,min} [mm]	70	80	90	96
	h _{ef,max} [mm]	140	220	300	380
Maximum torque moment	T _{inst,max} [Nm]	40	60	120	150
Minimum spacing	s _{min} [mm]	55	65	85	105
Minimum edge distance	c _{min} [mm]	55	65	85	105
Diameter of clearance hole in the fixture ²⁾	Pre-positioned anchorage d _f [mm]	14	18	22	26
	Push-through anchorage d _f [mm]	18	22	26	32
Minimum thickness of concrete member	h _{min} [mm]	h ₀ + 30	h ₀ + 2d ₀		

¹⁾ Both drill bit diameters can be used

²⁾ For larger clearance holes in the fixture see TR 029, 4.2.2.1 or CEN/TS 1992-4-1:2009, 5.2.3.1

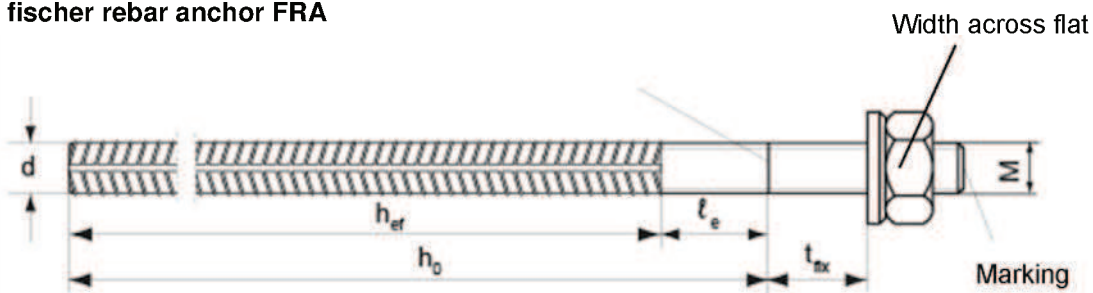
fischer rebar anchor FRA



Marking:  FRA (for stainless steel)
 FRA C (for high corrosion-resistant steel)

fischer injection system FIS V

Intended Use
 Installation parameters rebar anchor FRA

Annex B 5

Table B6: Parameters of steel brush FIS BS Ø

Drill bit diameter	[mm]	8	10	12	14	16	18	20	24	25	28	30	35
Steel brush diameter d_b	[mm]	9	11	14	16	20	20	25	26	27	30	40	40

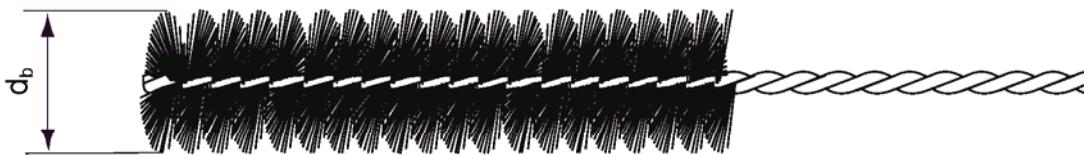

Table B7: Maximum processing time of the mortar and minimum curing time
(During the curing time of the mortar the concrete temperature may not fall below the listed minimum temperature).

Temperature at anchoring base [°C]			Minimum curing time ¹⁾ t_{cure} [minutes]			System temperature (mortar) [°C]	Maximum processing time t_{work} [minutes]		
			FIS VW High Speed	FIS V	FIS VS Low Speed		FIS VW High Speed	FIS V	FIS VS Low Speed
-10	to	-5	12 hours						
>-5	to	±0	3 hours	24 hours		±0	5		
>±0	to	+5	3 hours	3 hours	6 hours	+5	5	13	
>+5	to	+10	50	90	3 hours	+10	3	9	20
>+10	to	+20	30	60	2 hours	+20	1	5	10
>+20	to	+30		45	60	+30		4	6
>+30	to	+40		35	30	+40		2	4

¹⁾ For wet concrete or flooded hole the curing time must be doubled.

fischer injection system FIS V



Intended Use
Cleaning tools / Processing - and curing times

Annex B 6

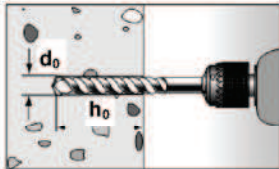
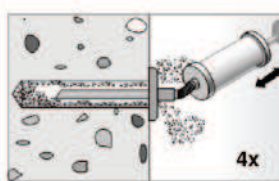
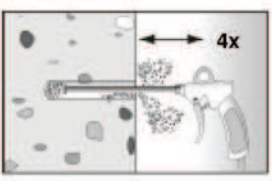
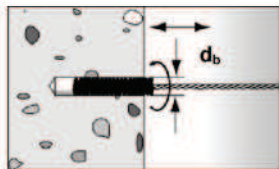
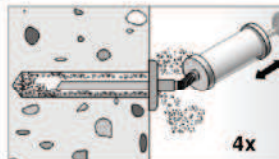
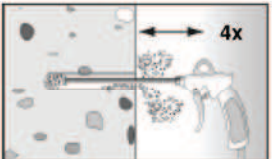
Installation instructions part 1
Drilling and cleaning the hole

1		<p>Drill the hole. Drill hole diameter d_0 and drill hole depth h_0 see Tables B2, B3, B4, B5.</p>	
2		<p>$h_{ef} \leq 12d$ and $d_0 < 18$ mm: Blow out the drill hole four times by hand.</p>	 <p>$h_{ef} > 12d$ and/or $d_0 \geq 18$ mm: Blow out the drill hole four times, using oil-free pressure air ($p > 6$ bar).</p>
3		<p>Brush the drill hole four times using an adequate steel brush (see Table B6).</p>	
4		<p>$h_{ef} \leq 12d$ and $d_0 < 18$ mm: Blow out the drill hole four times by hand.</p>	 <p>$h_{ef} > 12d$ and/or $d_0 \geq 18$ mm: Blow out the drill hole four times, using oil-free pressure air ($p > 6$ bar).</p>

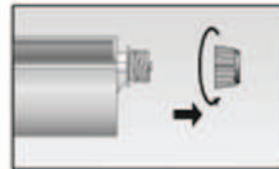
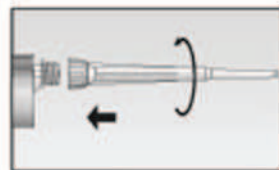
Preparing the cartridge

5		<p>Twist off the sealing cap.</p>	
6		<p>Twist on the static mixer (the spiral in the static mixer must be clearly visible).</p>	
7		<p>Place the cartridge into the dispenser.</p>	
8		<p>Press out approx. 10 cm of mortar until the resin is permanent grey in colour. Mortar which is not grey in colour will not cure and must be disposed of.</p>	

fischer injection system FIS V

Intended Use
Installation instructions part 1

Annex B 7





Installation instructions part 2		Injection of the mortar	
9	 <p>Fill approx... 2/3 of the drill hole with mortar. Always begin from the bottom of the hole to eliminate voids.</p>	 <p>For drill hole depth ≥ 150 mm use an extension tube.</p>	
Installation fischer anchor rods or internal threaded anchors RG MI			
10	  <p>Only use clean and oil-free anchor elements. Press the anchor rod or internal threaded anchor RG MI down to the bottom of the hole, turning it slightly while doing so. After inserting the anchor element, excess mortar must emerge around the anchor element.</p>		
	 <p>For overhead installation support the anchor element with wedges.</p>	 <p>For push-through installation fill the annular gap also with mortar.</p>	
11	 <p>Wait for the specified curing time t_{cure} see Table B7.</p>		
12	 <p>Mounting the fixture $T_{inst,max}$ see Tables B2 or B3</p>		
Installing reinforcing bars and fischer rebar anchors FRA			
10	 <p>FRA</p>	<p>Only use clean and oil-free rebars. Mark the reinforcing bar for setting depth. Using a turning movement, push the reinforcing bar or FRA vigorously into the filled hole up to the insertion depth marking. When reaching the setting depth marking surplus mortar must emerge around the anchor.</p>	
11	 <p>Wait for the specified curing time t_{cure} see Table B7.</p>		
12	 <p>$T_{inst,max}$</p>	<p>Mounting the fixture $T_{inst,max}$ see Table B5</p>	
fischer injection system FIS V			Annex B 8
Intended Use Installation instructions part 2			

Table C1: Characteristic values of resistance for threaded rods under tension loads in non-cracked and cracked concrete (Design according to TR 029)

Size				M6	M8	M10	M12	M16	M20	M24	M27	M30
Installation safety factor	Dry and wet concrete	γ_2	[-]	1,0								
	Flooded hole		[-]	--	1,2 ¹⁾							
Combined pullout and concrete cone failure												
Diameter of calculation d			[mm]	6	8	10	12	16	20	24	27	30
Characteristic bond resistance in non-cracked concrete C20/25. Dry and wet concrete												
Temperature range I ²⁾		$\tau_{Rk,ucr}$	[N/mm ²]	9,0	11,0	11,0	11,0	10,0	9,5	9,0	8,5	8,5
Temperature range II ²⁾		$\tau_{Rk,ucr}$	[N/mm ²]	6,5	9,5	9,5	9,0	8,5	8,0	7,5	7,0	7,0
Characteristic bond resistance in non-cracked concrete C20/25. Flooded hole												
Temperature range I ²⁾		$\tau_{Rk,ucr}$	[N/mm ²]	--	--	--	9,5	8,5	8,0	7,5	7,0	7,0
Temperature range II ²⁾		$\tau_{Rk,ucr}$	[N/mm ²]	--	--	--	7,5	7,0	6,5	6,0	6,0	6,0
Characteristic bond resistance in cracked concrete C20/25. Dry and wet concrete												
Temperature range I ²⁾		$\tau_{Rk,cr}$	[N/mm ²]	--	--	6,0	6,0	6,0	5,5	4,5	4,0	4,0
Temperature range II ²⁾		$\tau_{Rk,cr}$	[N/mm ²]	--	--	5,0	5,0	5,0	5,0	4,0	3,5	3,5
Characteristic bond resistance in cracked concrete C20/25. Flooded hole												
Temperature range I ²⁾		$\tau_{Rk,cr}$	[N/mm ²]	--	--	--	5,0	5,0	4,5	4,0	3,5	3,5
Temperature range II ²⁾		$\tau_{Rk,cr}$	[N/mm ²]	--	--	--	4,0	4,0	3,5	3,5	3,0	3,0
Increasing factor Ψ_c	C25/30	[-]		1,05								
	C30/37	[-]		1,10								
	C35/45	[-]		1,15								
	C40/50	[-]		1,19								
	C45/55	[-]		1,22								
	C50/60	[-]		1,26								
Splitting failure												
Edge distance $c_{cr,sp}$	$h/h_{ef} \geq 2,0$	[mm]		1,0 h_{ef}								
	$2,0 > h/h_{ef} > 1,3$	[mm]		4,6 $h_{ef} - 1,8 h$								
	$h/h_{ef} \leq 1,3$	[mm]		2,26 h_{ef}								
Spacing	$s_{cr,sp}$	[mm]		2 $c_{cr,sp}$								

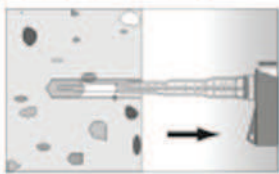
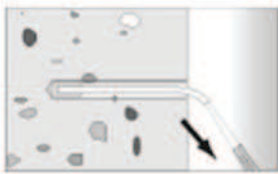
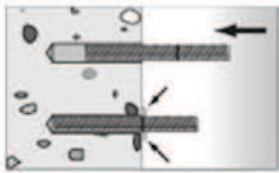
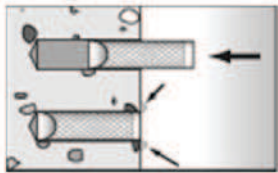
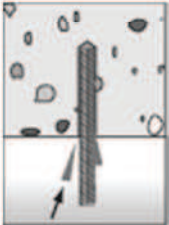
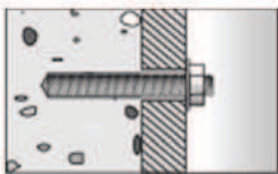
¹⁾ Only coaxial cartridges: 380 ml, 400 ml and 410 ml

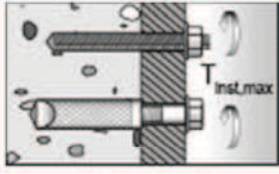
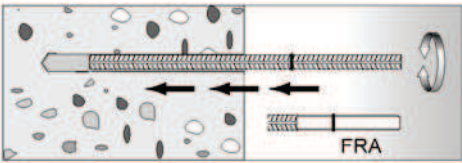
²⁾ See Annex B1

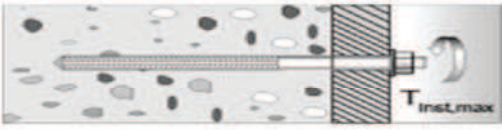
fischer injection system FIS V

Performances
 Characteristic values of resistance for threaded rods under tension load in non-cracked and cracked concrete (Design according to TR 029)

Annex C 1

Table C2: Characteristic values of resistance for internal threaded anchors RG MI under tension loads in non-cracked concrete (Design according to TR 029)

Size				M8	M10	M12	M16	M20
Installation safety factor	Dry and wet concrete	γ_z	[-]	1,0				
	Flooded hole		[-]	1,2 ¹⁾				
Steel failure								
Characteristic resistance with screw $N_{Rk,s}$	Property class	5.8	[kN]	19	29	43	79	123
		8.8	[kN]	29	47	68	108	179
	Property class 70	A4	[kN]	26	41	59	110	172
		C	[kN]	26	41	59	110	172
Combined pullout and concrete cone failure								
Diameter of calculation		d_H	[mm]	12	16	18	22	28
Characteristic bond resistance in non-cracked concrete C20/25. Dry and wet concrete								
Temperature range I ²⁾		$N_{Rk,p}^0$	[kN]	30	40	50	75	115
Temperature range II ²⁾		$N_{Rk,p}^0$	[kN]	25	30	40	60	95
Characteristic bond resistance in non-cracked concrete C20/25. Flooded hole								
Temperature range I ²⁾		$N_{Rk,p}^0$	[kN]	25	35	50	60	95
Temperature range II ²⁾		$N_{Rk,p}^0$	[kN]	20	25	35	50	75
Increasing factor Ψ_c	C25/30	[-]	1,05					
	C30/37	[-]	1,10					
	C35/45	[-]	1,15					
	C40/50	[-]	1,19					
	C45/55	[-]	1,22					
	C50/60	[-]	1,26					
Splitting failure								
Edge distance $c_{cr,sp}$	$h/h_{ef} \geq 2,0$	[mm]	$1,0 h_{ef}$					
	$2,0 > h/h_{ef} > 1,3$	[mm]	$4,6 h_{ef} - 1,8 h$					
	$h/h_{ef} \leq 1,3$	[mm]	$2,26 h_{ef}$					
Spacing	$s_{cr,sp}$	[mm]	$2 c_{cr,sp}$					

¹⁾ Only coaxial cartridges: 380 ml, 400 ml and 410 ml

²⁾ See Annex B1

fischer injection system FIS V

Performances

Characteristic values of resistance for internal threaded rods under tension load in non-cracked concrete (Design according to TR 029)

Annex C 2

Table C3: Characteristic values of resistance for reinforcing bars under tension loads in non-cracked and cracked concrete (Design according to TR 029)

Size	\emptyset	[mm]	8	10	12	14	16	20	25	28
Installation safety factor	γ_2	[-]	1,0							
Combined pullout and concrete cone failure										
Diameter of calculation	d	[mm]	8	10	12	14	16	20	25	28
Characteristic bond resistance in non-cracked concrete C20/25. Dry and wet concrete										
Temperature range I ¹⁾	$\tau_{Rk,ucr}$	[N/mm ²]	11,0	11,0	11,0	10,0	10,0	9,5	9,0	8,5
Temperature range II ¹⁾	$\tau_{Rk,ucr}$	[N/mm ²]	9,5	9,5	9,0	8,5	8,5	8,0	7,5	7,0
Characteristic bond resistance in cracked concrete C20/25. Dry and wet concrete										
Temperature range I ¹⁾	$\tau_{Rk,cr}$	[N/mm ²]	--	3,0	5,0	5,0	5,0	4,5	4,0	4,0
Temperature range II ¹⁾	$\tau_{Rk,cr}$	[N/mm ²]	--	3,0	4,5	4,5	4,5	4,0	3,5	3,5
Increasing factor Ψ_c	C25/30	[-]	1,05							
	C30/37	[-]	1,10							
	C35/45	[-]	1,15							
	C40/50	[-]	1,19							
	C45/55	[-]	1,22							
	C50/60	[-]	1,26							
Splitting failure										
Edge distance $c_{cr,sp}$	$h/h_{ef} \geq 2,0$	[mm]	1,0 h_{ef}							
	$2,0 > h/h_{ef} > 1,3$	[mm]	4,6 $h_{ef} - 1,8 h$							
	$h/h_{ef} \leq 1,3$	[mm]	2,26 h_{ef}							
Spacing	$s_{cr,sp}$	[mm]	2 $c_{cr,sp}$							

¹⁾ See Annex B1

fischer injection system FIS V

Performances

Characteristic values of resistance for reinforcing bars in non-cracked and cracked concrete under tension load (Design according to TR 029)

Annex C 3

Table C4: Characteristic values of resistance for rebar anchors FRA under tension loads in non-cracked and cracked concrete (Design according to TR 029)

Size			M12	M16	M20	M24
Installation safety factor	γ_2	[-]	1,0			
Steel failure						
Characteristic resistance	$N_{Rk,s}$	[kN]	63	111	173	270
Partial safety factor	$\gamma_{Ms,N}^{1)}$	[-]	1,4			
Combined pullout and concrete cone failure						
Diameter of calculation	d	[mm]	12	16	20	25
Characteristic bond resistance in non-cracked concrete C20/25. Dry and wet concrete						
Temperature range I ²⁾	$\tau_{Rk,ucr}$	[N/mm ²]	11,0	10,0	9,5	9,0
Temperature range II ²⁾	$\tau_{Rk,ucr}$	[N/mm ²]	9,0	8,5	8,0	7,5
Characteristic bond resistance in cracked concrete C20/25. Dry and wet concrete						
Temperature range I ²⁾	$\tau_{Rk,cr}$	[N/mm ²]	5,0	5,0	4,5	4,0
Temperature range II ²⁾	$\tau_{Rk,cr}$	[N/mm ²]	4,5	4,5	4,0	3,5
Increasing factor Ψ_c	C25/30	[-]	1,05			
	C30/37	[-]	1,10			
	C35/45	[-]	1,15			
	C40/50	[-]	1,19			
	C45/55	[-]	1,22			
	C50/60	[-]	1,26			
Splitting failure						
Edge distance $c_{cr,sp}$	$h/h_{ef} \geq 2,0$	[mm]	1,0 h_{ef}			
	$2,0 > h/h_{ef} > 1,3$	[mm]	4,6 $h_{ef} - 1,8 h$			
	$h/h_{ef} \leq 1,3$	[mm]	2,26 h_{ef}			
Spacing	$s_{cr,sp}$	[mm]	2 $c_{cr,sp}$			

¹⁾ In absence of other national regulations

²⁾ See Annex B1

fischer injection system FIS V

Performances

Characteristic values of resistance for rebar anchors FRA in non-cracked and cracked concrete under tension load (Design according to TR 029)

Annex C 4

**Table C5: Characteristic values of resistance for threaded rods under shear loads
(Design according to TR 029)**

Size	M6	M8	M10	M12	M16	M20	M24	M27	M30
Concrete pryout failure									
Factor k in equation (5.7) of TR 029 for the design of Bonded Anchor	k	[-]		2,0					

**Table C6: Characteristic values of resistance for internal threaded rods RG MI under shear loads
(Design according to TR 029)**

Size	M8	M10	M12	M16	M20			
Installation safety factor	γ_2	[-]		1,0				
Steel failure without lever arm								
Characteristic resistance $V_{RK,S}$	Property class	5.8	[kN]	9,2	14,5	21,1	39,2	62,0
		8.8	[kN]	14,6	23,2	33,7	62,7	90,0
	Property class 70	A4	[kN]	12,8	20,3	29,5	54,8	86,0
		C	[kN]	12,8	20,3	29,5	54,8	86,0
Steel failure with lever arm								
Characteristic resistance $M^0_{RK,S}$	Property class	5.8	[Nm]	20	39	68	173	337
		8.8	[Nm]	30	60	105	266	519
	Property class 70	A4	[Nm]	26	52	92	232	454
		C	[Nm]	26	52	92	232	454
Concrete pryout failure								
Factor k in equation (5.7) of TR 029 for the design of Bonded Anchor	k	[-]		2,0				

fischer injection system FIS V

Performances

Characteristic values of resistance for threaded rods and internal threaded anchors RG MI under shear load (Design according to TR 029)

Annex C 5

**Table C7: Characteristic values of resistance for reinforcing bars under shear loads
(Design according to TR 029)**

Size	Ø	[mm]	8	10	12	14	16	20	25	28
Concrete pryout failure										
Factor k in equation (5.7) of Technical Report TR 029, Section 5.2.3.3	k	[-]	2,0							

**Table C8: Characteristic values of resistance rebar anchors FRA under shear loads
(Design according to TR 029)**

Size			M12	M16	M20	M24
Steel failure without lever arm						
Characteristic resistance	$V_{RK,S}$	[kN]	30	55	86	124
Partial safety factor	$\gamma_{Ms,V}^{1)}$	[-]	1,56			
Steel failure with lever arm						
Characteristic resistance	$M^0_{RK,S}$	[Nm]	92	233	454	785
Partial safety factor	$\gamma_{Ms,V}^{1)}$	[-]	1,56			
Concrete pryout failure						
Factor k in equation (5.7) of TR 029 for the design of Bonded Anchor	k	[-]	2,0			

¹⁾ In absence of other national regulations

fischer injection system FIS V

Performances

Characteristic values of resistance for reinforcing bars and rebar anchors FRA under shear loads (Design according to TR 029)

Annex C 6

Table C9: Characteristic values of resistance for threaded rods under tension loads in non-cracked and cracked concrete (Design according to CEN/TS 1992-4)

Size			M6	M8	M10	M12	M16	M20	M24	M27	M30
Installation safety factor γ_{inst}	Dry and wet concrete	[-]	1,0								
	Flooded hole	[-]	--			1,2 ¹⁾					
Steel failure											
Characteristic resistance	$N_{Rk,s}$	[kN]	$A_s \times f_{uk}$								
Combined pullout and concrete cone failure											
Diameter of calculation	d	[mm]	6	8	10	12	16	20	24	27	30
Characteristic bond resistance in non-cracked concrete C20/25. Dry and wet concrete											
Temperature range I ²⁾	$\tau_{Rk,ucr}$	[N/mm ²]	9,0	11,0	11,0	11,0	10,0	9,5	9,0	8,5	8,5
Temperature range II ²⁾	$\tau_{Rk,ucr}$	[N/mm ²]	6,5	9,5	9,5	9,0	8,5	8,0	7,5	7,0	7,0
Characteristic bond resistance in non-cracked concrete C20/25. Flooded hole											
Temperature range I ²⁾	$\tau_{Rk,ucr}$	[N/mm ²]	--	--	--	9,5	8,5	8,0	7,5	7,0	7,0
Temperature range II ²⁾	$\tau_{Rk,ucr}$	[N/mm ²]	--	--	--	7,5	7,0	6,5	6,0	6,0	6,0
Characteristic bond resistance in cracked concrete C20/25. Dry and wet concrete											
Temperature range I ²⁾	$\tau_{Rk,cr}$	[N/mm ²]	--	--	6,0	6,0	6,0	5,5	4,5	4,0	4,0
Temperature range II ²⁾	$\tau_{Rk,cr}$	[N/mm ²]	--	--	5,0	5,0	5,0	5,0	4,0	3,5	3,5
Characteristic bond resistance in cracked concrete C20/25. Flooded hole											
Temperature range I ²⁾	$\tau_{Rk,cr}$	[N/mm ²]	--	--	--	5,0	5,0	4,5	4,0	3,5	3,5
Temperature range II ²⁾	$\tau_{Rk,cr}$	[N/mm ²]	--	--	--	4,0	4,0	4,0	3,5	3,0	3,0
Increasing factor Ψ_c	C25/30	[-]	1,05								
	C30/37	[-]	1,10								
	C35/45	[-]	1,15								
	C40/50	[-]	1,19								
	C45/55	[-]	1,22								
	C50/60	[-]	1,26								
Factor acc. CEN/TS 1992-4:2009 Section 6.2.2.3	k_g	cracked concrete	[-]	7,2							
	k_g	non-cracked concrete	[-]	10,1							
Concrete cone failure											
Factor acc. CEN/TS 1992-4:2009 Section 6.2.3.1	k_{cr}	cracked concrete	[-]	7,2							
	k_{ucr}	non-cracked concrete	[-]	10,1							
Edge distance $c_{cr,sp}$	$h/h_{ef} \geq 2,0$	[mm]	1,0 h_{ef}								
	$2,0 > h/h_{ef} > 1,3$	[mm]	$4,6 h_{ef} - 1,8 h$								
	$h/h_{ef} \leq 1,3$	[mm]	$2,26 h_{ef}$								
Spacing	$s_{cr,sp}$	[mm]	$2 c_{cr,sp}$								

¹⁾ Only coaxial cartridges: 380 ml, 400 ml and 410 ml

²⁾ See Annex B1

fischer injection system FIS V

Performances

Characteristic values of resistance for threaded rods under tension load in non-cracked and cracked concrete (Design according to CEN/TS-1992-4)

Annex C 7

Table C10: Characteristic values of resistance for internal threaded anchors RG MI under tension loads in non-cracked concrete (Design according to CEN/TS 1992-4)

Size				M8	M10	M12	M16	M20
Installation safety factor γ_{inst}	Dry and wet concrete	[-]		1,0				
	Flooded hole	[-]		1,2 ¹⁾				
Steel failure								
Characteristic resistance with screw $N_{RK,S}$	Property class	5.8	[kN]	19	29	43	79	123
		8.8	[kN]	29	47	68	108	179
	Property class 70	A4	[kN]	26	41	59	110	172
		C	[kN]	26	41	59	110	172
Partial safety factor $\gamma_{Ms,N}$ ³⁾	Property class	5.8	[-]	1,50				
		8.8	[-]	1,50				
	Property class 70	A4	[-]	1,87				
		C	[-]	1,87				
Combined pullout and concrete cone failure								
Diameter of calculation d			[mm]	12	16	18	22	28
Characteristic bond resistance in non-cracked concrete C20/25								
Dry and wet concrete								
Temperature range I ²⁾		$N_{RK,p}^0$	[kN]	30	40	50	75	115
Temperature range II ²⁾		$N_{RK,p}^0$	[kN]	25	30	40	60	95
Characteristic bond resistance in non-cracked concrete C20/25								
Flooded hole								
Temperature range I ²⁾		$N_{RK,p}^0$	[kN]	25	35	50	60	95
Temperature range II ²⁾		$N_{RK,p}^0$	[kN]	20	25	35	50	75
Increasing factor ψ_c	C25/30		[-]	1,05				
	C30/37		[-]	1,10				
	C35/45		[-]	1,15				
	C40/50		[-]	1,19				
	C45/55		[-]	1,22				
	C50/60		[-]	1,26				
Factor acc. CEN/TS 1992-4-5:2009 Section 6.2.2.3			k_8	[-]	10,1			
Concrete cone failure								
Factor acc. CEN/TS 1992-4-5:2009 Section 6.2.3.1			k_{ucr}	[-]	10,1			
Edge distance $c_{cr,sp}$	$h/h_{ef} \geq 2,0$		[mm]	$1,0 h_{ef}$				
	$2,0 > h/h_{ef} > 1,3$		[mm]	$4,6 h_{ef} - 1,8 h$				
	$h/h_{ef} \leq 1,3$		[mm]	$2,26 h_{ef}$				
Spacing $s_{cr,sp}$			[mm]	$2 c_{cr,sp}$				

¹⁾ Only coaxial cartridges: 380 ml, 400 ml and 410 ml

²⁾ See Annex B1

³⁾ In absence of other national regulations

fischer injection system FIS V

Performances

Characteristic values of resistance for internal threaded anchors RG MI under tension load in non-cracked concrete (Design according to CEN/TS 1992-4)

Annex C 8

Table C11: Characteristic values of resistance for reinforcing bars under tension loads in non-cracked and cracked concrete (Design according to CEN/TS 1992-4)

Size	\emptyset	[mm]	8	10	12	14	16	20	25	28
Installation safety factor	γ_{inst}	[-]	1,0							
Steel failure										
Characteristic resistance	$N_{Rk,s}$	[kN]	$A_s \times f_{uk}$							
Combined pullout and concrete cone failure										
Diameter of calculation	d	[mm]	8	10	12	14	16	20	25	28
Characteristic bond resistance in non-cracked concrete C20/25. Dry and wet concrete										
Temperature range I ¹⁾	$\tau_{Rk,ucr}$	[N/mm ²]	11,0	11,0	11,0	10,0	10,0	9,5	9,0	8,5
Temperature range II ¹⁾	$\tau_{Rk,ucr}$	[N/mm ²]	9,5	9,5	9,0	8,5	8,5	8,0	7,5	7,0
Characteristic bond resistance in cracked concrete C20/25. Dry and wet concrete										
Temperature range I ¹⁾	$\tau_{Rk,cr}$	[N/mm ²]	--	3,0	5,0	5,0	5,0	4,5	4,0	4,0
Temperature range II ¹⁾	$\tau_{Rk,cr}$	[N/mm ²]	--	3,0	4,5	4,5	4,5	4,0	3,5	3,5
Increasing factor Ψ_c	C25/30	[-]	1,05							
	C30/37	[-]	1,10							
	C35/45	[-]	1,15							
	C40/50	[-]	1,19							
	C45/55	[-]	1,22							
	C50/60	[-]	1,26							
Factor acc. CEN/TS 1992-4-5: 2009 Section 6.2.2.3	k_8	cracked concrete	[-]	7,2						
	k_8	non-cracked concrete	[-]	10,1						
Concrete cone failure										
Factor acc. CEN/TS 1992-4-5: 2009 Section 6.2.3.1	k_{cr}	cracked concrete	[-]	7,2						
	k_{ucr}	non-cracked concrete	[-]	10,1						
Edge distance	$c_{cr,N}$	[mm]	1,5 h_{ef}							
Axial distance	$s_{cr,N}$	[mm]	3,0 h_{ef}							
Splitting failure										
Edge distance $c_{cr,sp}$	$h/h_{ef} \geq 2,0$	[mm]	1,0 h_{ef}							
	$2,0 > h/h_{ef} > 1,3$	[mm]	4,6 $h_{ef} - 1,8 h$							
	$h/h_{ef} \leq 1,3$	[mm]	2,26 h_{ef}							
Spacing	$s_{cr,sp}$	[mm]	2 $c_{cr,sp}$							

¹⁾ See Annex B1

fischer injection system FIS V

Performances

Characteristic values of resistance for reinforcing bars under tension load in non-cracked and cracked concrete (Design according to CEN/TS-1992-4)

Annex C 9

Table C12: Characteristic values of resistance for rebar anchors FRA under tension loads in non-cracked and cracked concrete (Design according to CEN/TS 1992-4)

Size			M12	M16	M20	M24
Installation safety factor	γ_{inst}	[-]	1,0			
Steel failure						
Characteristic resistance	$N_{Rk,s}$	[kN]	63	111	173	270
Partial safety factor	$\gamma_{Ms,N}^{1)}$	[-]	1,4			
Combined pullout and concrete cone failure						
Diameter of calculation	d	[mm]	12	16	20	25
Characteristic bond resistance in non-cracked concrete C20/25. Dry and wet concrete						
Temperature range I ²⁾	$\tau_{Rk,ucr}$	[N/mm ²]	11,0	10,0	9,5	9,0
Temperature range II ²⁾	$\tau_{Rk,ucr}$	[N/mm ²]	9,0	8,5	8,0	7,5
Characteristic bond resistance in cracked concrete C20/25. Dry and wet concrete						
Temperature range I ²⁾	$\tau_{Rk,cr}$	[N/mm ²]	5,0	5,0	4,5	4,0
Temperature range II ²⁾	$\tau_{Rk,cr}$	[N/mm ²]	4,5	4,5	4,0	3,5
Increasing factor ψ_c	C25/30	[-]	1,05			
	C30/37	[-]	1,10			
	C35/45	[-]	1,15			
	C40/50	[-]	1,19			
	C45/55	[-]	1,22			
	C50/60	[-]	1,26			
Factor acc. CEN/TS 1992-4-5: 2009 Section 6.2.2.3	k_g	cracked concrete	[-]	7,2		
	k_g	non-cracked concrete	[-]	10,1		
Concrete cone failure						
Factor acc. CEN/TS 1992-4-5: 2009 Section 6.2.3.1	k_{cr}	cracked concrete	[-]	7,2		
	k_{ucr}	non-cracked concrete	[-]	10,1		
Edge distance $c_{cr,sp}$	$h/h_{ef} \geq 2,0$	[mm]	1,0 h_{ef}			
	$2,0 > h/h_{ef} > 1,3$	[mm]	4,6 $h_{ef} - 1,8 h$			
	$h/h_{ef} \leq 1,3$	[mm]	2,26 h_{ef}			
Spacing	$s_{cr,sp}$	[mm]	2 $c_{cr,sp}$			

¹⁾ In absence of other national regulations

²⁾ See Annex B1

fischer injection system FIS V

Performances

Characteristic values of resistance for rebar anchors FRA under tension load in non-cracked and cracked concrete (Design according to CEN/TS-1992-4)

Annex C 10

**Table C13: Characteristic values of resistance for threaded rods under shear loads
(Design according to CEN/TS 1992-4)**

Size	M6	M8	M10	M12	M16	M20	M24	M27	M30
Installation safety factor γ_{inst} [-]	1,0								
Steel failure without lever arm									
Characteristic resistance $V_{Rk,s}$ [kN]	0,5 $A_s \times f_{uk}$								
Ductility factor acc. to CEN/TS 1992-4-5:2009 Section 6.3.2.1 k_2 [-]	0,8								
Steel failure with lever arm									
Characteristic resistance $M^0_{Rk,s}$ [Nm]	1,2 $\times W_{el} \times f_{uk}$								
Concrete pryout failure									
Factor in equation of CEN/TS 1992-4-5:2009 Section 6.3.3 k_3 [-]	2,0								
Concrete edge failure									
Effective length of anchor l_f [mm]	$l_f = \min (h_{ef}, 8 d_{nom})$								
Outside diameter of anchor d_{nom} [mm]	6	8	10	12	16	20	24	27	30

Table C14: Characteristic values of resistance for internal threaded rods RG MI under shear loads in non-cracked concrete (Design according to CEN/TS 1992-4)

Size	M8	M10	M12	M16	M20	
Installation safety factor γ_{inst} [-]	1,0					
Steel failure without lever arm						
Characteristic resistance $V_{Rk,s}$	Property class 5.8 [kN]	9,2	14,5	21,1	39,2	62,0
	Property class 8.8 [kN]	14,6	23,2	33,7	62,7	90,0
	Property class A4 [kN]	12,8	20,3	29,5	54,8	86,0
	Property class 70 C [kN]	12,8	20,3	29,5	54,8	86,0
Ductility factor acc. to CEN/TS 1992-4-5:2009 Section 6.3.2.1 k_2 [-]	0,8					
Steel failure with lever arm						
Characteristic resistance $M^0_{Rk,s}$	Property class 5.8 [Nm]	20	39	68	173	337
	Property class 8.8 [Nm]	30	60	105	266	519
	Property class A4 [Nm]	26	52	92	232	454
	Property class 70 C [Nm]	26	52	92	232	454
Concrete pryout failure						
Factor in equation of CEN/TS 1992-4-5:2009 Section 6.3.3 k_3 [-]	2,0					
Concrete edge failure						
Outside diameter of anchor d_{nom} [mm]	8	10	12	16	20	

fischer injection system FIS V

Annex C 11

Performances

Characteristic values of resistance for threaded rods and internal threaded anchors RG MI under shear loads (Design according to CEN/TS 1992-4)

**Table C15: Characteristic values of resistance for reinforcing bars under shear loads
(Design according to CEN/TS 1992-4)**

Size	Ø	[mm]	8	10	12	14	16	20	25	28
Installation safety factor	γ_{inst}	[-]	1,0							
Steel failure without lever arm										
Characteristic resistance	$V_{Rk,s}$	[kN]	$0,5 A_s \times f_{uk}$							
Ductility factor acc. to CEN/TS 1992-4-5:2009 Section 6.3.2.1	k_2	[-]	0,8							
Characteristic resistance	$M^0_{Rk,s}$	[Nm]	$1,2 \times W_{el} \times f_{uk}$							
Concrete pryout failure										
Factor in equation of CEN/TS 1992-4-5:2009 Section 6.3.3	k_3	[-]	2,0							
Concrete edge failure										
Outside diameter of anchor	d_{nom}	[mm]	8	10	12	14	16	20	25	28

**Table C16: Characteristic values of resistance for rebar anchors FRA under shear loads
(Design according to CEN/TS 1992-4)**

Size			M12	M16	M20	M24
Installation safety factor	γ_{inst}	[-]	1,0			
Steel failure without lever arm						
Characteristic resistance	$V_{Rk,s}$	[kN]	30	55	86	124
Partial safety factor	$\gamma_{Ms,V}^{1)}$	[-]	1,56			
Ductility factor acc. to CEN/TS 1992-4-5:2009 Section 6.3.2.1	k_2	[-]	0,8			
Steel failure with lever arm						
Characteristic resistance	$M^0_{Rk,s}$	[Nm]	92	233	454	785
Partial safety factor	$\gamma_{Ms,V}^{1)}$	[-]	1,56			
Concrete pryout failure						
Factor in equation of CEN/TS 1992-4-5, Section 6.3.3	k_3	[-]	2,0			
Concrete edge failure						
Outside diameter of anchor	d_{nom}	[mm]	12	16	20	24

¹⁾ In absence of other national regulations

fischer injection system FIS V

Performances

Characteristic values of resistance for reinforcing bars and rebar anchors FRA under shear loads (Design according to CEN/TS 1992-4)

Annex C 12

Table C17: Displacements under tension load ¹⁾ for threaded rods

Size		M6	M8	M10	M12	M16	M20	M24	M27	M30
Non-cracked concrete										
δ_{N0} -Factor	[mm/N/mm ²]	0,09	0,09	0,09	0,10	0,10	0,10	0,10	0,11	0,12
$\delta_{N\infty}$ -Factor	[mm/N/mm ²]	0,10	0,10	0,10	0,12	0,12	0,12	0,13	0,13	0,14
Cracked concrete										
δ_{N0} -Factor	[mm/N/mm ²]	--	--	0,12	0,12	0,13	0,13	0,13	0,14	0,15
$\delta_{N\infty}$ -Factor	[mm/N/mm ²]	--	--	0,27	0,30	0,30	0,30	0,35	0,35	0,40

¹⁾ Calculation of the displacement

$$\delta_{N0} = \delta_{N0}\text{-Factor} \cdot \tau$$

$$\delta_{N\infty} = \delta_{N\infty}\text{-Factor} \cdot \tau$$

Table C18: Displacements under shear load ¹⁾ for threaded rods

Size		M6	M8	M10	M12	M16	M20	M24	M27	M30
δ_{V0} -Factor	[mm/kN]	0,11	0,11	0,11	0,10	0,10	0,09	0,09	0,08	0,07
$\delta_{V\infty}$ -Factor	[mm/kN]	0,12	0,12	0,12	0,11	0,11	0,10	0,10	0,09	0,09

¹⁾ Calculation of the displacement

$$\delta_{N0} = \delta_{N0}\text{-Factor} \cdot V$$

$$\delta_{N\infty} = \delta_{N\infty}\text{-Factor} \cdot V$$

Table C19: Displacements under tension load ¹⁾ for internal threaded anchors RG MI

Size		M8	M10	M12	M16	M20
δ_{N0} -Factor	[mm/N/mm ²]	0,1	0,11	0,12	0,13	0,14
$\delta_{N\infty}$ -Factor	[mm/N/mm ²]	0,13	0,14	0,15	0,16	0,18

¹⁾ Calculation of the displacement

$$\delta_{N0} = \delta_{N0}\text{-Factor} \cdot \tau$$

$$\delta_{N\infty} = \delta_{N\infty}\text{-Factor} \cdot \tau$$

Table C20: Displacements under shear load ¹⁾ for internal threaded anchors RG MI

Size		M8	M10	M12	M16	M20
δ_{V0} -Factor	[mm/kN]	0,12	0,12	0,12	0,12	0,12
$\delta_{V\infty}$ -Factor	[mm/kN]	0,14	0,14	0,14	0,14	0,14

¹⁾ Calculation of the displacement

$$\delta_{N0} = \delta_{N0}\text{-Factor} \cdot V$$

$$\delta_{N\infty} = \delta_{N\infty}\text{-Factor} \cdot V$$

fischer injection system FIS V

Performances

Displacements threaded rods and internal threaded anchor RG MI

Annex C 13

Table C21: Displacements under tension load ¹⁾ for reinforcing bars

Size	Ø	[mm]	8	10	12	14	16	20	25	28
Non-cracked concrete										
δ _{N0} -Factor		[mm/N/mm ²]	0,09	0,09	0,10	0,10	0,10	0,10	0,10	0,11
δ _{N∞} -Factor		[mm/N/mm ²]	0,10	0,10	0,12	0,12	0,12	0,12	0,13	0,13
Cracked concrete										
δ _{N0} -Factor		[mm/N/mm ²]	--	0,12	0,12	0,13	0,13	0,13	0,13	0,14
δ _{N∞} -Factor		[mm/N/mm ²]	--	0,27	0,30	0,30	0,30	0,30	0,35	0,37

¹⁾ Calculation of the displacement

$$\delta_{N0} = \delta_{N0}\text{-Factor} \cdot \tau$$

$$\delta_{N\infty} = \delta_{N\infty}\text{-Factor} \cdot \tau$$

Table C22: Displacements under shear load ¹⁾ for reinforcing bars

Size	Ø	[mm]	8	10	12	14	16	20	25	28
δ _{V0} -Factor		[mm/kN]	0,11	0,11	0,10	0,10	0,10	0,09	0,09	0,08
δ _{V∞} -Factor		[mm/kN]	0,12	0,12	0,11	0,11	0,11	0,10	0,10	0,09

¹⁾ Calculation of the displacement

$$\delta_{N0} = \delta_{N0}\text{-Factor} \cdot V$$

$$\delta_{N\infty} = \delta_{N\infty}\text{-Factor} \cdot V$$

Table C23: Displacements under tension load ¹⁾ for rebar anchor FRA

Size		M12	M16	M20	M24
Non-cracked concrete					
δ _{N0} -Factor	[mm/N/mm ²]	0,10	0,10	0,10	0,10
δ _{N∞} -Factor	[mm/N/mm ²]	0,12	0,12	0,12	0,13
Cracked concrete					
δ _{N0} -Factor	[mm/N/mm ²]	0,12	0,13	0,13	0,13
δ _{N∞} -Factor	[mm/N/mm ²]	0,30	0,30	0,30	0,35

¹⁾ Calculation of the displacement

$$\delta_{N0} = \delta_{N0}\text{-Factor} \cdot \tau$$

$$\delta_{N\infty} = \delta_{N\infty}\text{-Factor} \cdot \tau$$

Table C24: Displacements under shear load ¹⁾ for rebar anchor FRA

Size		M12	M16	M20	M24
δ _{V0} -Factor	[mm/kN]	0,1	0,1	0,09	0,09
δ _{V∞} -Factor	[mm/kN]	0,11	0,11	0,10	0,1

¹⁾ Calculation of the displacement

$$\delta_{N0} = \delta_{N0}\text{-Factor} \cdot V$$

$$\delta_{N\infty} = \delta_{N\infty}\text{-Factor} \cdot V$$

fischer injection system FIS V

Performances

Displacements reinforcing bars and rebar anchor FRA

Annex C 14